



WWW20-P

[User Manual]

Please read and follow the installation and operating instructions provided.

Table of Contents

- I. **Introduction** 1
- II. **Installation Instructions** 2
 - Step #1 Lay out your frame
 - Step #2 Connect Left and Right Frame to Hitch
 - Step #3 Connect your toolbar
 - Step #4 Connect Your Wings
 - Step #5 Insert the Wheels
 - Step #6 Attach the Tank
 - Step #7 Connecting the Sponges
 - Step #8 Attaching your boom
 - Step #9 Plumbing and Manifold options
 - Step #10 Connect Your Wiper to Your Hitch
 - Step #11 Using the wiper with your sprayer and installing the electrical wire harness
- III. **Operating Instructions**10
 - Before You Start
 - Mixing Instructions
 - Field Adjustments
- IV. **Maintenance Requirements**.....12
 - Common Filter Maintenance
 - Operating At Freezing Temperatures
- V. **Policies and Information**13

IMPORTANT:

YOUR SMUCKER WEED WIPER COMES WITH A 2 YEAR MANUFACTURES WARRANTY. PLEASE SAVE YOUR RECEIPT FOR PROOF OF PURCHASE. CONTACT THE DEALER THAT YOU PURCHASES YOUR WIPER FORM WITH ANY WARRANTY ISSUES.

INTRODUCTION

Congratulations on your purchase of a Smucker Super Sponge® Weed Wiper!

The Super Sponge® is a lightweight, durable, herbicide applicator. Our sponges are designed to apply the maximum amount of product to the target weeds without any drift. The sponge applicators are made of industrial-strength, crusted sponge that stay saturated with chemical to wipe directly onto weeds. Our sponge weed wiper and top crop kits are applicators. Smucker Manufacturing makes no guarantee of any and all chemical use through the sponge application. Please read all chemical labeling concerning the weed wiper instructions.

The Super Sponge® has proven to be a quick and efficient way to wipe out weeds in your crops in many independent studies and we are confident you will be pleased with the results. We value our customers, and we would appreciate any input or comments you may have regarding your new Super Sponge® wiper.

You can visit our smuckermfg.net website page for reference to all weed wiper parts and diagrams. If you still have questions, give us a call and we can even help you locate your closest Smucker dealer.

Also, visit www.smuckermfg.net or ask your dealer about the other product lines we offer. We offer premium products at an affordable price. Take a look at our Foam Markers, Calf Warmers, and VisionWorks camera systems for farm equipment on our website.

www.smuckermfg.net

www.redweeder.com

www.visionworkscameras.com

Scan QR codes below with your smart phone

Mobile website for VisionWorks Cameras

Smucker Mobile website



Installation Instructions

Thank you for purchasing a Pull-Type Weed Wiper kit. Please follow the directions provided carefully. We recommend assembling this unit with two people. You should expect a 1-1 ½ hours assembly time.

Please refer to your Parts Inventory Sheet when installing your Weed Wiper.

Step #1 Lay out your frame

Lay your frame out on the ground in conjunction to the image below. This will be your finished product.



Do not worry, we will go into detail later about the assembly of your weed wiper. This is only for your visual reference.

Step #2 Connect Left and Right Frame to Hitch

NB3820



NB38NU



NB38LO



Insert your main frame left and main frame right into the tank and hitch stand assembly. **Make sure to secure your brackets in so that the wheel brackets are sticking up** (as pictured). Secure your frame members with the 3/8" x 2" bolts provided (NB3820 QTY: 4) with the 3/8" lock washers (NB38LO QTY: 4) and 3/8" nuts (NB38NU QTY: 4) provided. Do not over tighten these bolts.

Tank and Hitch Stand Assembly

Bolt Inserts

Wheel Brackets sticking up

Main frame right

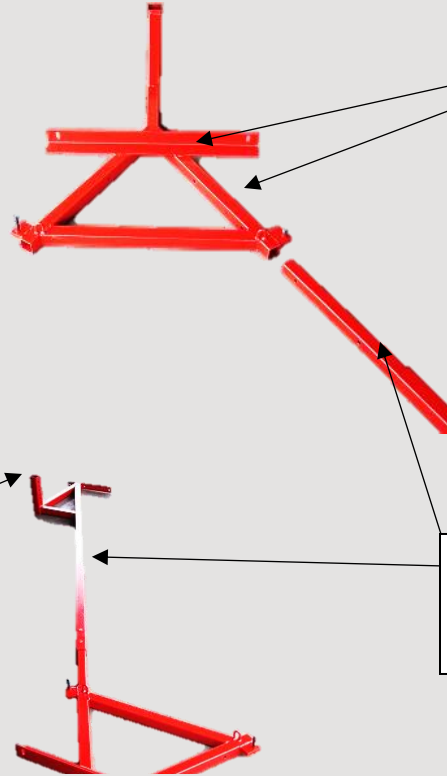

Step #3 Connect your toolbar

NB3830



NB38NU



NB38LO



Bolt your rear toolbar to the back of your left frame and your right frame with 3/8" x 3" (NB3830 QTY: 6) bolts (with the 3/8" lock washers (NB38LO QTY: 6) & 3/8" nuts (NB38NU QTY: 6) on **each side** using the inside holes. **Make sure that the angled iron brackets pictured below are facing toward the front of your weed wiper model (i.e. towards the front hitch).**

Insert toolbar here



Step #4 Connect Your Wings

Grab your 5' wings (WW1411 QTY: 2) and attach your wings to your toolbar assembly. Use the 3/8" x 10" bolt (NB3899 QTY: 2) and the 3/8" Jam nuts (NB38NU QTY: 2 per bolt) to attach your wings to your toolbar. Lock your wing into position with your RC Pin (WR4240 QTY: 2). The wings are mounted with the angle iron sponge tabs toward the front. Notice that the wheel brackets are in the upright position below. **Be sure to attach them so that your wing angle iron tabs are facing the opposite direction of your toolbar angle iron tabs (see picture).**

Notice the wheel brackets are in the upright position.

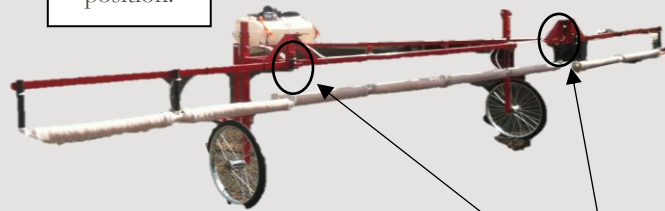

Angle Iron tabs

3/8" x 10" bolt.



NB38NU



RC Pin

Step #5 Insert the wheels

WW2520



NB75FL



NB1316



Insert the wheel legs (#8) into the sockets (#9) on both the right and left side of the frame as pictured below. Secure your wheel with 3 flat washers (NB75FL) per wheel and the 3/16" x 1 1/2" Lynch pin (NB1316) to lock your wheel in. Secure your wheel leg in at the preferred height with one PTO pin (WW2520) per wheel. **IMPORTANT:** Use a 1/2" x 1 1/4" bolt to tighten the wheel legs and hitch stand in the socket of each leg and hitch (NB5012 & NB50NU). This is necessary to remove rattle and sway when driving the machine at higher speeds.

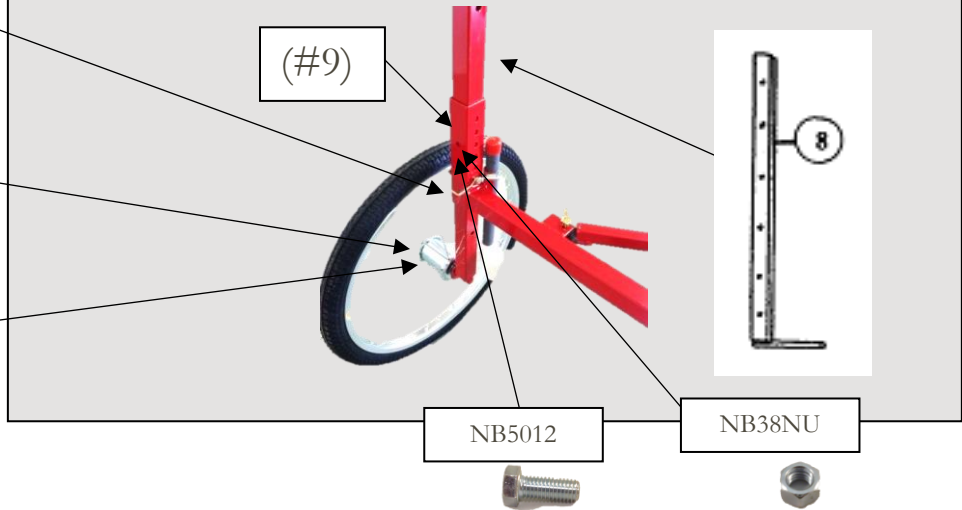

Step #6 Attach the Tank

Attach the tank and pump assembly (SPS014-WW) with tie down straps as pictured (SPS002). Note: **This is a 20 ft. pull type pictured, only use for this picture is to note how the tank is attached.**



Step #7 Connecting the Sponge Sections

The first step is to lay out each of the 30" sponge sections (WWTC30 QTY: 8) included in the kit, and connect them together as pictured with our PVC, "Tee" risers (WW2346-TC QTY: 11). This particular unit will have 3 different sponge sections. One section will be 10 ft., and two will be in 5 ft. increments (5 risers and 4 sponges per 10 ft. section, 3 risers and 2 sponges per 5 ft. section). Do not worry, it's okay to end your boom with a, "Tee" since there is no chemical flow through the risers. The 5' sections are for your wings.

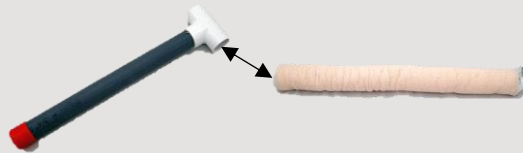

IMPORTANT: DO NOT glue your sponge sections into your PVC, "Tees." Hammer them together with a mallet (as shown in the picture below). It's **very important** that you connect your sponge sections with the push to connect elbow facing up (as pictured) with the blue mark on your white caps facing forward from your boom, in the direction you will wipe, at the one o'clock position (as pictured). Notice that your push to connect elbow will be on the same side for each of your sponges across your boom (as pictured next page).

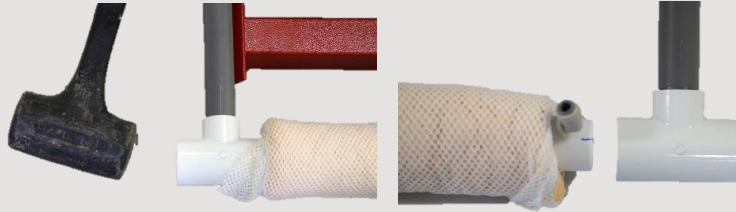

Push to Connect Elbow Facing Same Direction

Make sure, as you hammer in your elbow, that you get your sponge wet and hammer the elbow in until the edge of the cap reaches the center of the, "Tee." After hammering in your risers, make sure you stretch your sponges out over your T-risers so that your boom is almost entirely covered by your sponges (Sponges must be wet to do this).

Step #8 Attaching your boom

From there simply clamp your, “Tee” risers onto the metal angle iron tabs with the clamps included CL0016 (QTY: 22). Make sure that you clamp each, “Tee” riser at the same height to ensure that your sponge boom is level (as pictured next page).

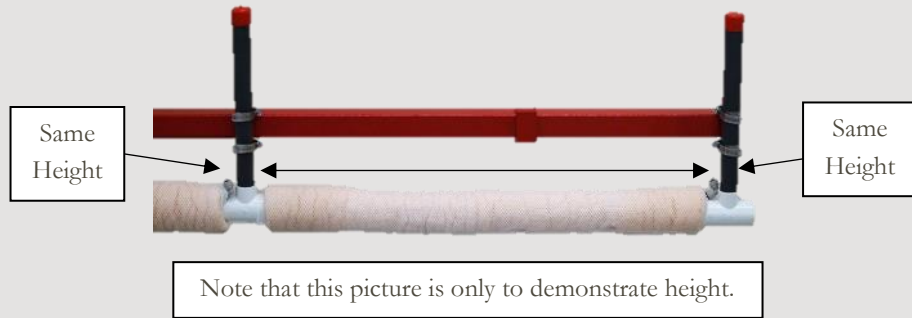

Step #9 Mounting your Manifold and plumbing your unit

Your kit comes with a manifold system (WWTCM8P), which connects to the tank’s equipment pump outlet. First, mount the provided manifold system to the **CENTER** of your boom frame (i.e. the center of your weed wiper), as pictured, with the zip ties provided (NY108H QTY: 22). **If you do not mount to the center of your boom frame, the tubing sections we recommend below will not reach all of your sponges.**

Find the center of your 20 ft. boom. Zip tie it in a secure position. Note pictured position may not be your center. The picture is only meant for visual reference of a secure position

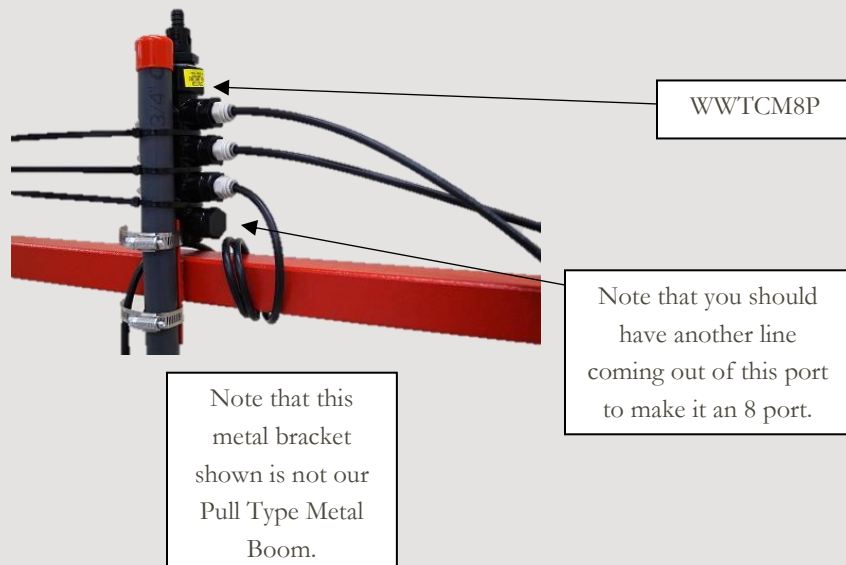

(Step #9 continued)

We provide the pump needed to power your weed wiper and the vinyl tubing (VL0038 QTY: 15 ft.) needed to run from your manifold to your pump (since your manifold has been mounted to the center of the boom). Use our CL0916 clamps to secure your tubing to your manifold. Any extra 3/8" tubing may be coiled up. Now, connect your manifold inlet to your spray pump as pictured.



The manifold included has quick connectors to supply product to each of the 30" sponge section (in this case there are six ports). Cut your WW1215 1/4" black tubing evenly (Recommendation 12.5 ft. QTY: 8) to plumb from your manifold to your individual sponge sections. **It's extremely important that each sponge assembly is supplied with the same length of tubing to ensure equal chemical flow.** Any extra tubing for the closer sponge sections can just be coiled up or zip tied (View picture below for a visual). Do not over tighten the zip ties and pinch the tubing.

Simply push the tubing into the quick connectors on both your sponge section, and your manifold (as pictured). The only way to remove the tubing is to depress the grey ring around the push to connect fitting, while pulling out on the tubing.

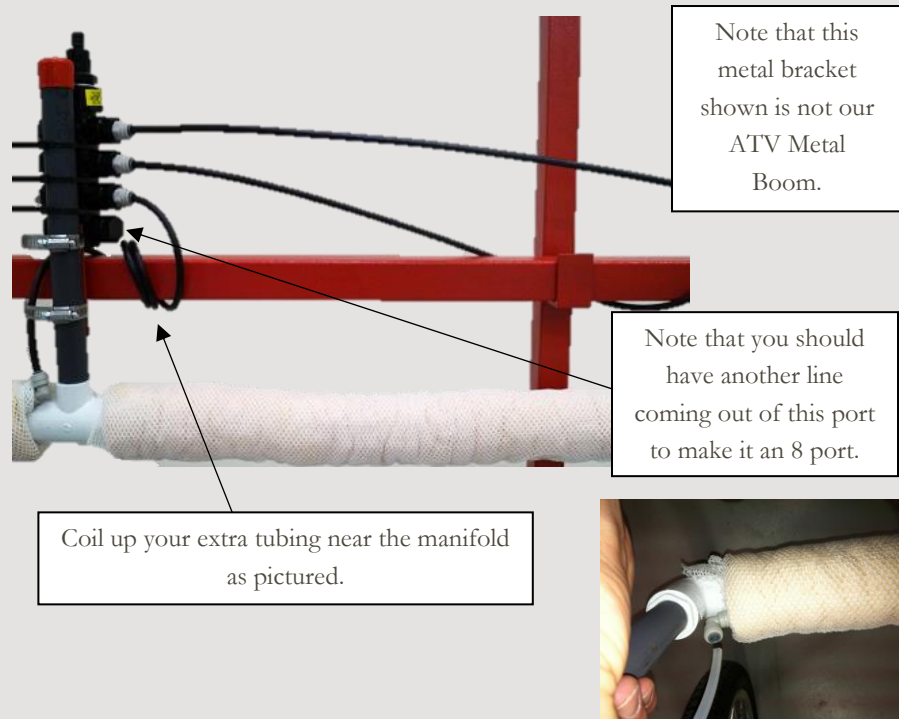

Step #10 Connect your Wiper to your Hitch

WW2520



Take your hitch stand and insert it into your front hitch insert in the picture below. Secure your hitch at the desired height with a PTO pin (WW2520). Don't forget to secure with a (NB5012 & NB50NU) used in step #5.

Insert your hitch into this slot.



Step #11 Using the weed wiper with your sprayer. Installing the electrical wire harness

Install the wire harness (SPS117) according to the instructions included with the wire harness. Then, mount the switch in a position that can be reached by the operator.

When the pump is on, chemical will be pumped out of the PVC through small holes, and into the sponges. This pump fed system will ensure quick filling of the sponges and instant shut off when the switch is turned to off.

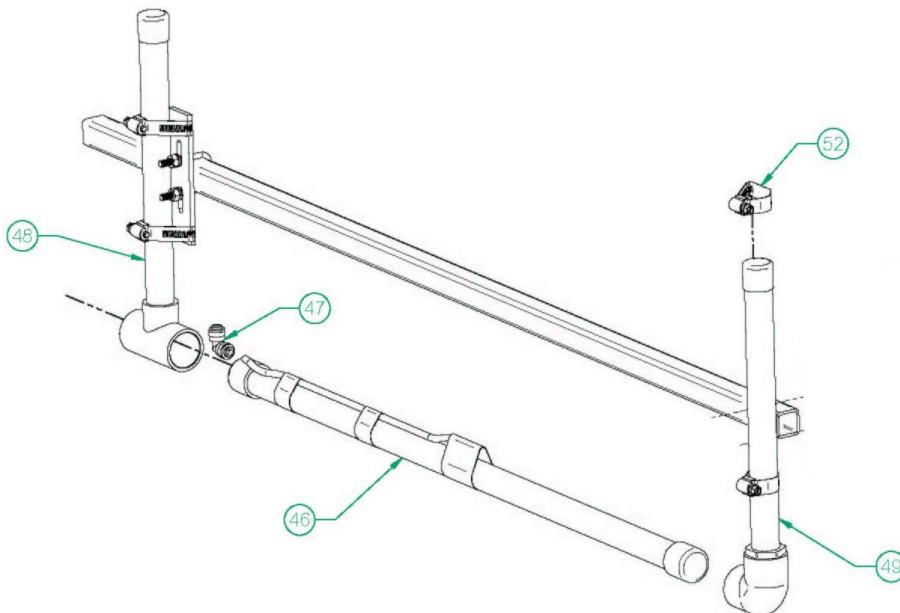

Operating Instructions

The Pull-Type Weed Wiper is a very effective contact herbicide applicator usually used to apply non-selective herbicides to weeds growing above crops. Proper set-up, adjustment, operation, and maintenance are essential to assure effective weed control while protecting the crop from herbicide damage.

Before You Start

1. Before you start using your sponge weed wiper in the field, always get the sponges wet with water. When sponges are dry, they are hard and less effective. Wetting your sponges with a garden hose before use, allows you to work out any dry spots before any application. We strongly recommend that you fill them up with water, and ring them out before turning on your chemical flow.
 2. Next, we recommend that you run water through your tank to check your sponges for even feeding. Therefore, before filling the tank with chemicals, put water in your tank and turn on your pump until you see the sponges dripping. Watch for even dripping throughout the full length of the wiper. Unlike a conventional sprayer, you cannot see plugged nozzles on a wiper during operation. Always check for uniform feeding before heading out into the field.
 3. Once even feeding is attained, drain your product tank by removing the 3/8" supply tubing from the black filter. Squeeze the excess water from the sponges and fill the tank with the chemical solution following our mixing instructions below. Then turn on your pump until you see the sponges fully saturated (almost dripping), which typically will only take a few seconds. Once your sponges are saturated, you are ready to go!
-

Mixing Instructions

The most common product to use in a wiper is Glyphosate. The manufacturing label recommends a 33% mix rate, however, please follow **your** label for mix rates in a wiping applicator/contact herbicide applicator. It's important to remember that the ratio of herbicide to water can vary depending on the weeds to be controlled, the time of year, and the temperature. Contact your chemical field man or extension service for best herbicide mix and or surfactant for specific weed and crop conditions.

If you are trying to control Glyphosate resistance weeds follow the label for Paraquat. The label, in most states for controlling Palmer Amaranth, is listed at a 50% mix rate. However, **always follow the label.**

Field Adjustments

Adjust the height of the sponges to just above crop level and contact as much of the weed as possible, without contacting the crop.

Turn on the master on/off switch only when you believe you need more chemical, only for a short amount of time, and begin wiping at 5-7 MPH. Try to maintain a proper level of product in the sponges to maintain good coverage without dripping. While you are still unfamiliar with turning the pump on and off to adjust the chemical flow, it's usually better to set the wiper too wet and have a little dripping, rather than have it set too dry and have poor weed kill.

Folding Wings For Into Road Position

On a 20 foot model pull out your RC pin and adjust it to desired angle.



Maintenance Requirements

Common Sponge Maintenance

The protective netting over the sponge is replaceable and is cheap to replace if you can replace the netting before the cellulose sponge is damaged. Therefore, we recommend that you check your sponges often for wear and tear.

If you need your sponge netting replaced, ask us for part number (WW2302). If you need your sponge replaced, ask us for part number (WW2301).

Storage Maintenance

Do not store the system over the off-season with chemical in the lines. A film will form on the tubing and can plug the small feedholes. Avoid this by flushing your system thoroughly with water at the end of the season. However, it's also advisable to flush the system with water and spray the sponges with water to remove chemical, which may cause the sponge to harden, after every use.

Check and clean the black filter, inside the tank, as needed. At the end of the season, store your weed wiper in a dry place, out of direct sunlight.
